



Model Number

V1-W-E8W-OR3M-POC

Female cordset, M12, 4-pin, TPE cable, welding-bead resistant

Features

- Resistant to welding bead formation
- Suitable for robotic applications / torsion resistant
- Does not give off silicone
- Ozone resistant
- Built-in LED, as operating and function indicator
- Knurled nut suitable for tool assembly
- Immunity to vibration, with mechanical latching
- Gold-plated and machined contacts
- Degree of protection IP67 / IP68 / IP69K

Dimensions

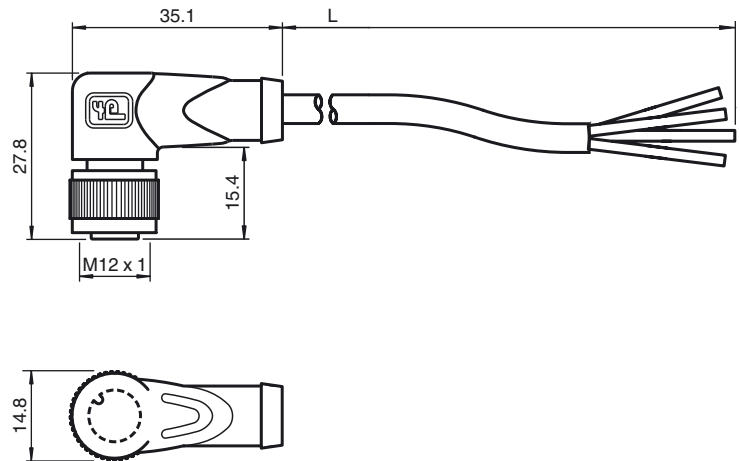

Technical data

General specifications

Number of pins	4
----------------	---

Indicators/operating means

LED green	Operating display
LED yellow	Functional display NO contact 4
LED white	Functional display NO contact 2

Electrical specifications

Operating voltage	U_B	max. 24 V DC \pm 15%
Operating current	I_B	max. 4 A
Volume resistance		< 5 m Ω

Ambient conditions

Ambient temperature	Body: -40 ... 90 °C (-40 ... 194 °F) Cable, flexing: -15 ... 120 °C (5 ... 248 °F) for 20000 h -15 ... 150 °C (5 ... 302 °F) for 3000 h cable, fixed: -40 ... 120 °C (-40 ... 248 °F) for 20000 h -40 ... 150 °C (-40 ... 302 °F) for 3000 h
Pollution degree	3

Mechanical specifications

Contact elements	spring-loaded contact socket
Pin diameter	1 mm
Degree of protection	IP67 / IP68 / IP69k
Material	
Contacts	CuSn / Au
Contact surface	Au
Body	TPU, transparent
Cable	TPE resistant to welding bead formation
Slotted nut	Diecast zinc
Core insulation	ETFE
Cable	fine-strand, flexible
Sheath diameter	\varnothing 4.8 mm
Bending radius	> 10 x cable diameter, moving
Color	orange
Cores	4 x 0.34 mm ²
Conductor construction	19 x 0.16 mm \varnothing
Length	L 3 m
Flammability	
Contact carrier	HB
Housing	V-2
Cable	flame-resistant

Compliance with standards and directives

Standard conformity	
---------------------	--

Electrical connection

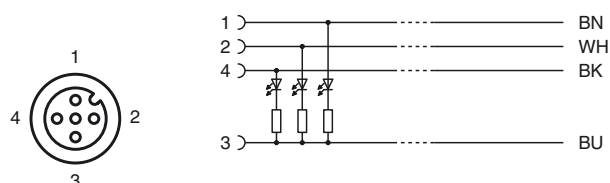



Degree of protection	EN 60529:2000
Standards	IEC 61076-2-101:2008
Flammability	Body: UL 94 Line: UL 1581 Section 1061; IEC 60332-1-2:2004

Release date: 2017-02-16 07:54 Date of issue: 2017-02-16 233461_eng.xml